

# PRATT

Henry Pratt Company

## Control Systems



**Engineering Creative Solutions  
for Fluid Systems Since 1901**

## Table of Contents

### Control Systems

#### Check-Mate

Details of Operation .....	1
Equipment Furnished .....	2
Suggested Specification .....	2

#### Low Pressure Oil Accumulator

Design Features .....	3
Suggested Specification .....	4

#### High Pressure Oil Accumulator

Design Features .....	5
Suggested Specification .....	5

#### Water Bladder Accumulator

Design Features .....	6
Suggested Specification .....	6

#### Electro-Check

Interface Systems.....	7
------------------------	---

<b>Diagnostic Electro-Check.....</b>	<b>8</b>
--------------------------------------	----------

<b>Interface Systems.....</b>	<b>9</b>
-------------------------------	----------

## PRATT PUMP CHECK SYSTEM PREVENTS THESE OPERATIONAL PROBLEMS

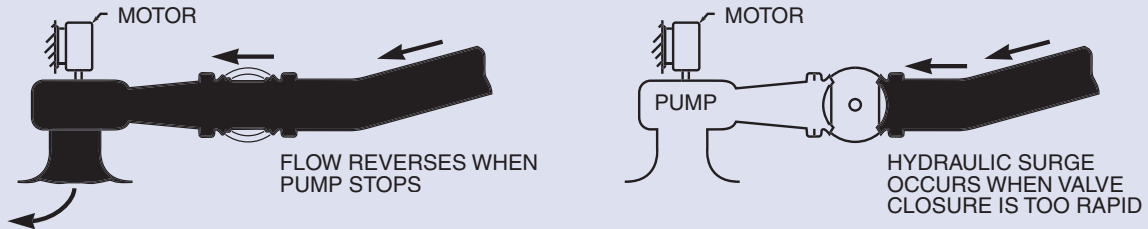

## Check Mate Details of Operation

### Normal Pump Start

In this mode, the pump motor circuit is energized, thereby starting the pump. As the pump comes up to speed, or design head, three basic methods are used to signal the Pratt pump check valve.

*Single Pressure Switch* – The pressure switch is tapped off the upstream side of the pump check valve. When the discharge pressure of the pump reaches a level greater than the downstream system head, the pressure switch trips, energizing the solenoid circuit to the four-way valve, opening the pump check valve. During pump start, the two-way solenoid valves are continuously energized when the pump is on line.

*Time Delay Relay* – This electrical device is part of the pump motor circuit. When the pump motor circuit is energized, the time delay relay is energized, preset to energize the four-way valve circuit, causing the Pratt pump check valve to open. The amount of time delay is related to the type of pump and the time it takes for the pump to come up to speed.

*Differential Pressure Switch* – This pressure switch is tapped off the downstream and upstream sides of the Pratt pump check valve. When the pump/motor circuit is energized, the differential pressure switch senses when the pump discharge pressure is greater than the downstream pressure, trips, closing the four-way valve circuit and causing the Pratt pump check valve to open.

### Normal Pump Stop

This mode of operation is selected when the pump is taken off line for reasons of demand, maintenance, etc. For normal close, the four-way valve circuit is de-energized, causing the Pratt pump check valve to close. (The two-way solenoid emergency bypass valves remain energized during normal pump stop). While the Pratt pump check valve moves toward the closed position, the pump/motor set continues to run. The pump/motor circuit is tripped off by a limit switch on the Pratt pump check valve. The point at which the limit switch trips out the pump/motor circuit relates to concerns of hydraulic surge in the system, pump speed, etc. For some installations the pump/motor circuit is tripped out prior to the Pratt pump check valve reaching the full closed position. On some systems, the Pratt pump check valve is fully closed prior to tripping out the pump/motor circuit. The settings of the limit switch which trips out the pump/motor circuit are normally made in the field.

When the pump/motor circuit is tripped out, the two-way solenoid emergency bypass circuit can be de-energized.

### Emergency Closure

This mode of operation usually occurs when an electric power failure causes the pump/motor set to stop. In an incident of this nature, the Pratt pump check valve must close at a rate more rapid than normal closure rates. The need for rapid closure of the Pratt pump check valve is to prevent a high reverse flow rate which can backspin the pump and cause damage to the pump/motor set and drain the system stored water.

On total electric power failure, the four-way valve and the two-way bypass emergency valves are de-energized. The bypass piping circuit parallels the four-way valve circuit and provides a larger cylinder supply flow rate to the Pratt pump check valve cylinder operator, resulting in rapid closure. If the pump check valve has the feature of emergency closure, it is recommended that the pumping system piping should include surge relief devices because the emergency rapid closure of any pump check valve will result in hydraulic surge.

### Control Function

#### Normal Pump Start

- Turn selector switch to “On” position
- Press pump start button, starting pump motor
- When pump comes up to desired head, the pressure switch closes, energizing the four-way valve circuit causing the Pratt pump check valve to open.

#### Normal Pump Stop

- Turn selector switch to “Off” position. This de-energizes four-way valve circuit causing the Pratt pump check valve to close.
- When the Pratt pump check valve reaches 75% to 95% close, the momentary limit switch trips, de-energizing the pump/motor circuit and shutting down the total system.

#### Emergency Closure

All circuits are de-energized simultaneously, allowing rapid closure through the two-way valve bypass piping.

On pump check service, valve starts to open only after pump has reached desired speed (or pressure). When fully open, ball provides full circular waterway with no more pressure drop than an equivalent length of pipe. If power loss to pump occurs, valve closes at desired speed to prevent reversal of flow toward pump. Upon complete closure, valve is bubble-tight against back flow towards the pump.

## Equipment Furnished

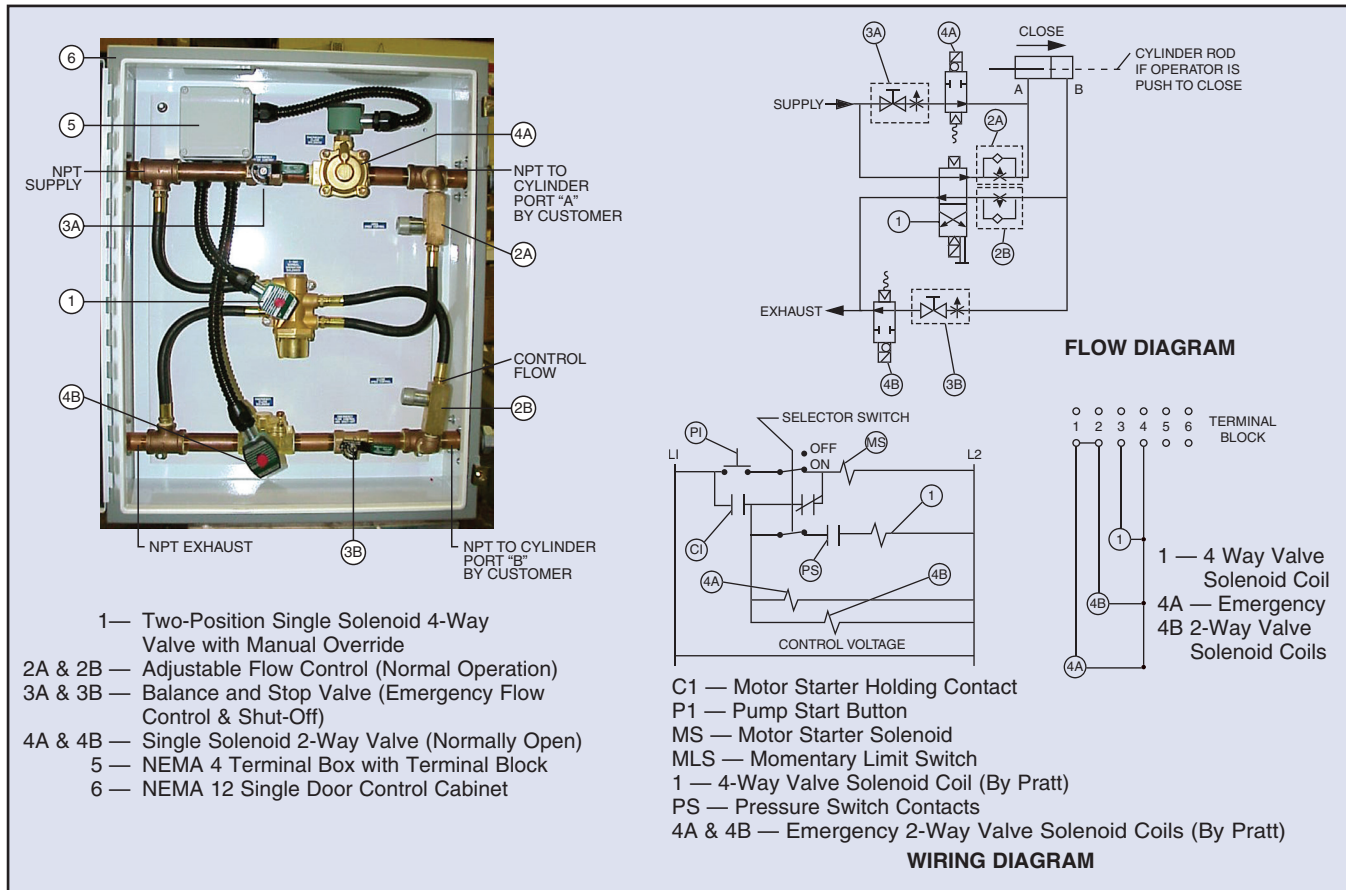

## Suggested Specifications

The control system for the pump check valve shall provide the following functions:

1. Independent adjustable rates of valve opening and closing operations.
2. Independent adjustable emergency closure rate resulting from an electric power failure or other operational signal eliminating power to the system.

The system shall be provided with a single solenoid four-way valve for the normal open and close function. Two solenoid operated two-way valves shall be provided for emergency closure, bypassing the single solenoid four-way valve. Separate adjustable speed control valves shall be furnished for open, close and emergency operation. The system shall be provided with a manual override for the normal open and close function.

The required speeds of operation shall be as follows:

- Normal open – 60 seconds minimum  
300 seconds maximum

- Normal close – 60 seconds minimum  
300 seconds maximum
- Emergency Close – 10 seconds minimum  
20 seconds maximum

The control system shall be fully piped and wired, and contained within a NEMA 12 cabinet with a hinged access door. Electrical wiring shall terminate in a separate NEMA 4 junction box within the control cabinet.

The pump check valve should be furnished with three limit switches. One each for the full open or full close positions, and the third switch shall provide momentary interruption of the pump motor control to initiate pump shutdown prior to 100% valve closure to minimize hydraulic surge.

The pump check system shall be the Check-Mate system as manufactured by the Henry Pratt Company.

# Low Pressure Oil Accumulator System

## Design Features

- Custom sized to match application
- Fully automatic system
- Between 10 and 500 gallons of usable oil delivered even with loss of electrical power
- System supply isolation valve provided for additional plant safety
- Sight gage with integral checks that automatically close with accidental breakage of gauge glass
- Low oil level switch in sump tank locks out pumps
- NEMA 12 electrical control cabinet (NEMA 4 shown)
- Air filter to remove excess moisture for air lines
- 200 mesh suction filters on each oil pump

The low pressure accumulator system consists of a cylindrical pressure tank, oil sump tank, NEMA cabinet, one (1) air compressor, two (2) motor driven oil pumps and all necessary controls and accessories mounted and piped on a fabricated steel base with lifting eyes.

## Pressure Tank – 100 to 1,000 gallons in size

The tank provides oil pressure between 80 psig minimum and 150 psig maximum with 150 psig air pressure above the oil. The tank is sized to stroke the hydraulic cylinders three (3) times between these pressures without electric power. Under normal operation with electric power, the controls start the oil pump when the pressure drops to 145 psig and stops the pumps when the proper oil level is reached. The pressure tank is constructed and tested in accordance with the latest ASME Code for Unfired Pressure Vessels and code stamped. Standard features include a relief valve, gauge glass with ball check gauge cocks, float switch and cleanout hole.

## Oil Sump Tank – With low level lock-out switch

The oil return sump tank of welded steel plate receives the working capacity of oil stored in the pressure tank. The reservoir is fitted with a gauge glass, a low level oil cut-off float switch, a drain connection and a screened fill cap.

## Oil Pumps/Air Compressor Units – For proper fluid control

The two positive displacement oil pumps wired in a lead/lag circuit maintain the correct oil level in the tank. They are sized to pump the usable oil volume in less than 10 minutes, 5 gpm minimum. Standard features are relief and isolation valves, a common outlet filter and controls necessary to maintain proper air pressure in the tank.

A single stage air compressor unit provides air under pressure to maintain the oil at 150 psig. The units recharge the pressure tank in less than 20 minutes, 3/4 scfm minimum. The unit is totally enclosed with a metal guard for safety. The compressor is equipped with relief valve, isolation valve, outlet filter and controls necessary to maintain proper air pressure in the tank.

If oil pump fails to perform its function or if the system demand is high, the lag pump will start. An alternator is provided so that, upon each charging cycle, a different pump will be started to equalize service loads.

## Electrical controls – Fully automatic

All of the controls, pressure switches, alternator and motor starters are mounted in a NEMA 12 enclosure with heavy duty oil tight panel lights, buttons and switches, for easy access and adjustment. The pressure gauge is mounted in the cabinet floor for high visibility. The controls make the system fully automatic and contain safety alarm circuits for low oil level or low pressure conditions to protect the equipment.

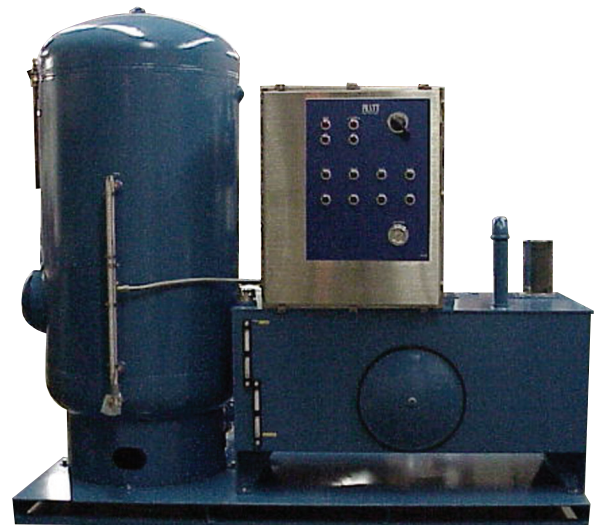

# Low Pressure Oil Accumulator System Suggested Specification

## General

An oil accumulator system shall be furnished to supply oil under pressure to actuate the hydraulic cylinder operated valves. The oil accumulator system shall consist of a vertical cylindrical pressure tank, rectangular oil sump tank, electrical cabinet, one (1) air compressors, two (2) motor driven oil pumps, and all necessary controls and appurtenances mounted and piped on a fabricated steel base with lifting eyes for floor mounting. The system shall be designed to use a petroleum base hydraulic oil with viscosity of 90 SUS at 100°F.

## Pressure Tank

The pressure tank shall be constructed and tested in accordance with the latest ASME Code for Unfired Pressure Vessels and code stamped. The tank shall be sized to stroke the hydraulic cylinders three (3) times between the pressures of 80 and 150 psig, with no electric power available. Under normal operation, with electric power for operating the oil pumps, the controls shall function to start the oil pumps when the pressure drops to 145 psig and stop the oil pumps when the proper oil level is reached. The pressure tank shall be equipped with a relief valve, gauge glass with ball check gauge cocks, float switch, drain, and a cleanout hole.

## Oil Return Reservoir

The oil return reservoir shall be constructed of a welded steel plate and shall be of ample size to receive the working capacity of oil stored in the pressure tank. It shall be fitted with a gauge glass, a low level oil cut off float switch, a drain connection, and a screened fill cap.

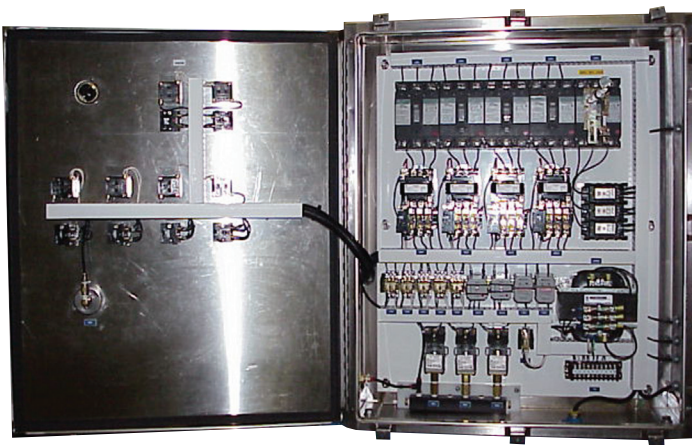

## Air Compressors/Oil Pumps

Two (2) motor-driven air compressors with relief valves, isolation valves, a common outlet filter, and controls necessary to maintain proper air pressure in the pressure tank shall be furnished. The units shall be sized to recharge the pressure tank in less than 10 minutes, 1-1/2 scfm minimum. Two (2) motor-driven oil pumps with relief valves, isolation valves, suction filters, and controls necessary to maintain proper oil level in the pressure tank shall also be furnished. The oil pumps shall be sized to pump the usable oil volume in less than 10 minutes, 5 gpm minimum. The oil pump shall work in an alternating lead/lag circuit so that, if the unit is unable to build pressure, the lag unit shall start.

## Control Cabinet

A NEMA 12 control cabinet containing a panel interlocked main circuit breaker, motor circuit breakers, motor circuit protectors, motor starters, control transformer, alarm reset buttons, Hand-Off-Auto switches, pilot lights, control relays, terminal strip, pressure gauge, three pressure switches, and any additional equipment necessary for proper operation of the system shall be provided. Motors shall be suitable for \_\_\_\_\_ volt, 3 phase, 60 cycle power and of the open drip proof construction. Lights, alarm contacts, and reset buttons shall be provided for the low oil level and low pressure alarm conditions.

## Miscellaneous

Interconnected piping between the hydraulic and pneumatic components shall be tubing or pipe. The supply and return lines shall be sized to assure minimum pressure loss at the emergency cylinder flow rate. The accumulator shall be connected to the hydraulic cylinders in the manufacturer's shop, filled to the normal operating level with oil, and tested to verify correct mechanical and electrical operation. All exposed carbon steel surfaces are to be cleaned thoroughly, removing all rust, scale, dirt, and grease, and painted with an industrial rust resistant primer and a waterproof industrial enamel. In preparation for shipment, all openings shall be plugged and all instrumentation adequately protected.

# High Pressure Oil Accumulator System

## Design Features

- Custom designed
- Between 1 and 100 gallons of usable oil after power failure
- Isolation valves on each accumulator for easy servicing
- System remains operational while an accumulator is serviced
- 10 micron return line filter to protect components
- NEMA 4 electrical cabinet

The high pressure system consists of a bank of nitrogen-charged accumulators, a pump/motor set mounted on an oil sump tank, an electrical motor control cabinet, and all the necessary controls and accessories.

## Accumulator Bank – Precharged cylinders

The bank of accumulators is sized to stroke the hydraulic cylinders three (3) times between the pressures of 1400 and 1000 psig. Pratt high pressure accumulator systems are available in all capacities, but always contain a minimum of two accumulators. A charging and gauging assembly is shipped with each rack to check pressures.

## Oil Pump/Motor Set and Sump Tank – With integral hydraulic controls

The positive displacement pump/motor set is sized to charge the accumulator with oil in less than five minutes, 1 gpm minimum. The open drip-proof motor is suitable for all 3 phase, 60 cycle power. The unit features an integral strainer, relief valve, gauge and level indicator.

## Control Cabinet – Manual and automatic operation

The NEMA 4 (rainproof/outdoor) electrical cabinet houses the motor starter, Hand-Off-Auto selector switch, start button and circuit breakers. Using the pressure switch, the unit will automatically start the oil pump when the pressure is below 1400 psig and stop the oil pump at 2500 psig. The control cabinet provides extra protection from dust and water, and is wall mounted.

## Suggested Specification

### General

A high pressure oil accumulator system shall be furnished to supply oil under pressure to actuate the hydraulic cylinder operated valves. The oil accumulator system shall consist of a pump/motor set mounted on an oil sump tank, an electrical motor control cabinet, a bank of accumulators, and all necessary controls and appurtenances. The system shall be designed to use a petroleum base hydraulic oil with a viscosity of 90 SUS at 100°F.

## Sump Tank

The sump tank shall be constructed of welded steel plate and shall be of ample size to receive the working capacity of the oil stored in the accumulators, 10 gallons minimum. It shall be fitted with a flush type fluid level indicator, a clean out cover, filler/breather, and a drain connection. In addition, the return connection shall contain a 10 micron screw canister type fluid filter with internal bypass.

## Pump/Motor Set

The positive displacement pump/motor set shall be sized to charge the accumulators with oil in less than five minutes, 1 gpm minimum. The motor shall be suitable for all 3 phase, 60 cycle power and of the open drip-proof construction.

## Control Cabinet

A NEMA 4 electrical control cabinet shall house a motor starter, Hand-Off-Auto selector switch, start button, and circuit breaker. Using the pressure switch, the unit shall function to automatically start the oil pump when the pressure is below 1400 psig and stop the oil pump at 2500 psig.

## Accumulator Bank

The oil pump shall charge a bank of accumulators (quantity two minimum) sized to stroke the hydraulic cylinders three (3) times between the pressures of 1400 and 1000 psig. The accumulators are to be nitrogen pre-charged, and built in accordance with the ASME Code for Unfired Pressure Vessels. The accumulators shall be affixed to a metal rack assembly for floor mounting. Each accumulator shall be fitted with an isolation ball valve and piped to a common header containing a system isolation valve and an accumulator drain valve. Supplied with the assembly shall be a charging gauging assembly.

## Miscellaneous

All piping and fittings shall be seamless steel tubing with a rated working pressure of 6000 psi. All exposed carbon steel surfaces are to be cleaned thoroughly, removing rust, scale, dirt, and grease, and painted with an industrial enamel. The pump motor set, electrical cabinet, and accumulators shall be connected to the hydraulic cylinders in the manufacturer's shop, filled to the normal operating level with oil, and tested to verify correct mechanical and electrical operation. In preparation for shipment, all openings shall be plugged and all instrumentation adequately protected.

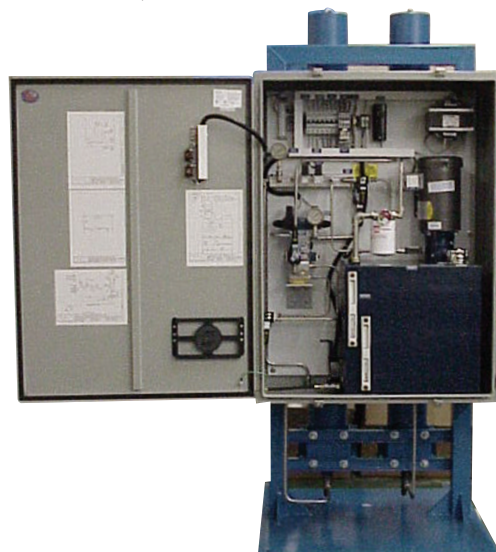

# Water Bladder Accumulator System

## Design Features

- Custom sized to match application
- Between 20 and 500 gallons of usable water supply.
- Standard fail-safe operation
- Requires only 110 volt power
- Fully automatic system
- Fully adjustable high/low water pressure
- NEMA 12 enclosure standard
- Corrosion proof fiberglass epoxy coated accumulators
- System design based on standard equipment
- Supply pressures up to 200 PSI

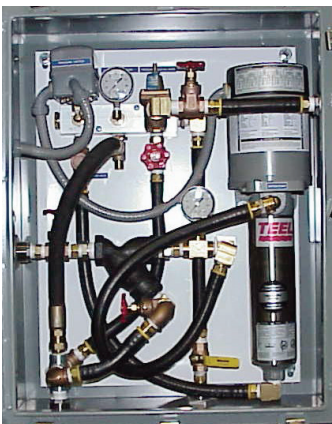

The water bladder accumulator system consists of a series of water accumulators combined with a fully piped pump and pressure control system housed inside a NEMA 12 enclosure. All water bladder control systems are skid mounted for ease of installation. Simply hook up the

water bladder system to any water supply and 110 volt service and the system is ready to be piped to any cylinder operator. The water bladder accumulators are pre-charged at the factory and suitable for all indoor locations.

## Benefits of the water bladder accumulator

- Fully automatic – self starting water pump
- 3X reserve supply in the event of a power failure
- Immediate high volume supply
- System recharges quickly for high service applications
- Stainless piping and NEMA 4X enclosures available
- Gages monitor accumulator pressure and system pressure
- Fully adjustable accumulator and system pressure settings
- Legend plates identify all critical components
- Easy replacement of components

## Suggested Specification

A water bladder accumulator system shall be furnished to supply water under pressure to actuate the hydraulic cylinder operated valves. The water bladder accumulator system shall consist of skid mounted tanks with a usable volume to cycle (fully closed to fully open to fully closed) the cylinder actuators 3 times at a minimum of 60 psig. The system shall be of a manufacturer who is regularly engaged in the manufacture of this equipment and shall be provided complete with interconnecting piping, valves, control panel and electrical equipment to operate as a single unit. The system shall be Pratt Water Bladder Accumulator Series WBA, or equal.





# Diagnostic Electro-Check and Standard Electro-Check

## Design Features

- Ice cube type relays for easy replacement
- Solid state timing relays for long life
- Flashing alarm lights provide high visibility
- Rigid NEMA 4 enclosure with terminal strip
- Heavy duty oil tight push buttons and lights for long life
- Remote alarm contacts

## Control Features

- Normal Pump Start – provides signaling of pump start and valves opening sequence. Also displays valve open or closed position and pump status
- Pump Stop – controls and monitors closure of check valve. Automatically stops pump at 70 – 95% closure

## Pump Safety Check Features

Monitors and safely controls valve and pump in the event of:

1. Loss of all electrical power
2. Pump motor overload
3. Failure of valve to open
4. Line blockage
5. Pump failure

## Electric Pump/Valve Interface Systems

Both systems are designed to work with either the Pratt Hydraulic Check-Mate or Air/Oil Check Mate units in controlling the pump and pump discharge ball or butterfly valve. Control panels provide for valve position and alarm indication, timed alarm control, and emergency stop capability. A relay will lock out the pump after an alarm condition arises, and a reset button must be pressed before the pump can be restarted. The enclosures are wall mountable and can be located at the valve or in the pump control room. Pratt modular control systems offer flexibility and safety as well.

At the Pratt Control System Center, each unit's control sequence is tested with the Pratt Pump System Simulator which matches the customer's pump and pressure switches. The pump check valve must work closely with the pump controls to function properly. This test procedure ensures compliance with design specifications and testifies to Pratt's professional approach.

## Diagnostic Electro-Check

### Monitors and Displays System Operational Status

Only Pratt's Diagnostic Control unit monitors three system parameters with three individual timers. Conditions are sensed by valve travel and pressure switches mounted on the pump discharge pipe. Therefore, any expected transient conditions can be filtered out by adjusting the appropriate timers.

Timer No. 1 is set to allow enough time for the pump to build pressure and the valve to begin opening. Timer No. 2 is set to the maximum allowable duration for a high pressure transient. Timer No. 3 is set to the maximum allowable duration for a low pressure transient. Then if any timer monitors an alarm condition for a time greater than its setting, it energizes a lockout relay and one of the three alarm lights – pump, Hi pressure or Lo pressure alarm. The cause of the emergency shutdown can be quickly identified by the three alarm lights.

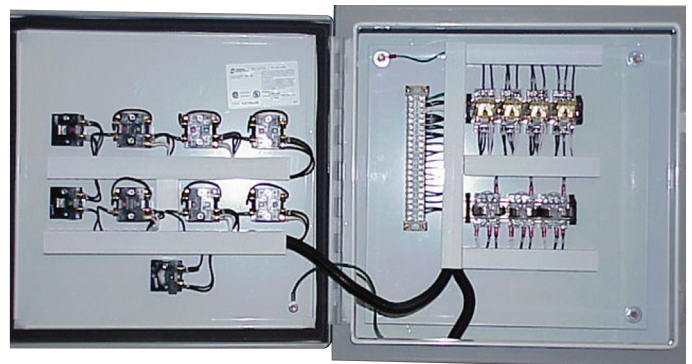

# Diagnostic Electro-Check Sequence of Operation

## Pump Start

1. Only the valve "Close" light is on.
2. A maintained pump signal is given at Terminal 3.
3. CR1 is energized, closing contacts (Lines 4 & 15).
4. CR1 contact (Line 4) energizes pump motor starter and pump "Run" light.
5. As pump discharge pressure rises. PS1 (Line 2) closes, energizing 4SV and opening the pump check valve. During valve travel, both "Open" and "Close" lights are on.
6. When valve is full open. LSO contact (Line 7) opens and the "Close" light is de-energized.
7. As the pump runs, the "Run" and "Open" lights are on.

## Pump Stop

1. The pump run signal is removed from Terminal 3.
2. 4 SV is de-energized, starting pump check valve closure.
3. CR1 is de-energized, opening contacts (Lines 4 & 15).
4. The pump continues to run, powered thru the closed LSC, MLS and MSH contacts (line 5).
5. When the pump check valve is 70-95% closed, MLS opens momentarily and de-energizes the pump motor starter. If MLS is not used, LSC will turn off pump when valve is fully closed.
6. Pump "Run" and valve "Open" lights are de-energized.

## Pump Safety Stop

1. Upon loss of all electrical power, the 2SV solenoids (Line 3) are de-energized, closing the pump check valve at the emergency rate.
2. If the pump motor starter overloads (Line 5) open, 4SV and 2SV are de-energized, closing the pump check valve at the emergency rate.
3. Line pressure and valve position are continuously monitored by PS2, PS3, and LSC. If the emergency exists for the time setting on its timing relay, TR1, TR2, or TR3, then the corresponding alarm lockout relay and alarm light will be energized. Pump safety shut down begins by opening one of the alarm contacts on Line 1 – valve will close and the MLS (Line 5) will shut down the pump. The pump can not be re-started until "Reset" (Line 9) is pressed. The pump safety stop sequence will be initiated under the following conditions:
  - a. If the valve fails to begin opening in the time set on TR1 (Line 15).
  - b. In case of line blockage or inadvertent valve closure, the pump discharge pressure will rise to the pump shut-off pressure and close PS2 (Line 16).

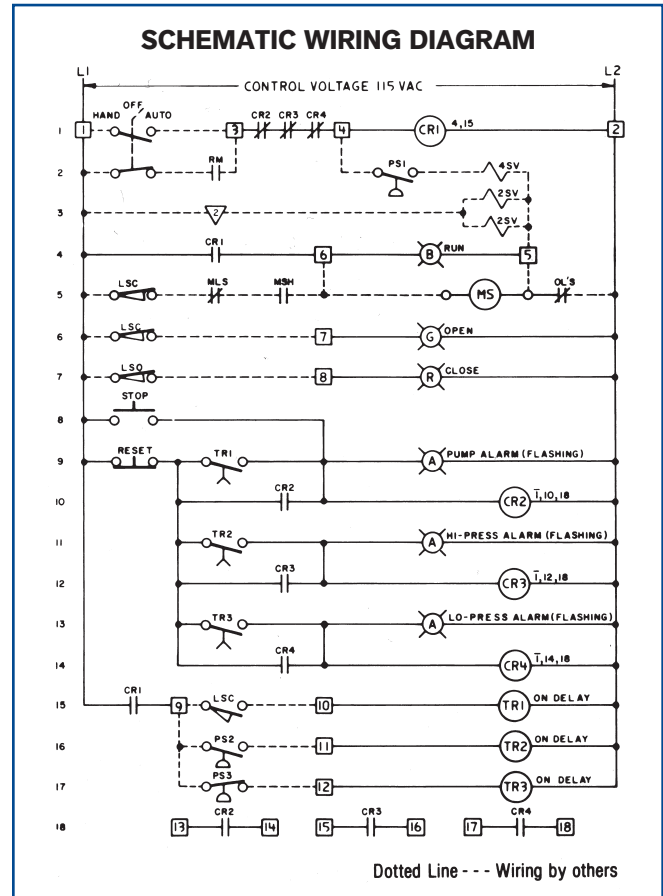
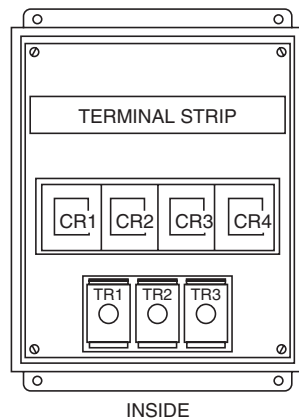

- a. In case of line break or parallel pump trip, the pump discharge pressure will fall below normal pressure and close PS3 (Line 17).
- d. In case of local emergency, the red "Stop" button (Line 8) can be pressed. The valve will close at the normal rate and shut off the pump at MLS (Line 5) setting.
- e. Remote alarm contacts: CR2, CR3 and CR4 (Line 18), are provided. (10 amps. Max.)

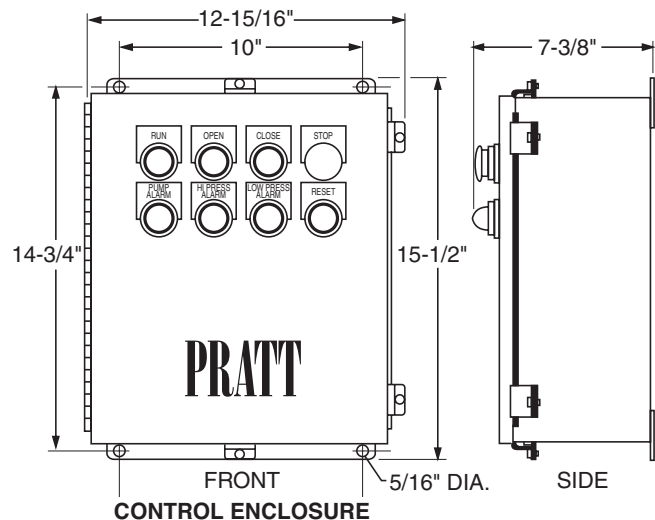

# Standard Electro-Check Sequence of Operation

## Pump Start

1. Only the valve "Close" light is on.
2. A maintained pump signal is given at Terminal 3
3. CR1 is energized, closing contact (Line 4).
4. CR1 contact (Line 4) energizes pump motor starter and pump "Run" light.
5. As pump discharge pressure rises, PS1 (Line 2) closes, energizing 4SV and opening the pump check valve. During valve travel, both "Open" and "Close" lights are on.
6. When valve is full open, LSO contact (Line 7) opens and the "Close" light is de-energized.
7. As the pump runs, the "Run" and "Open" lights are on.

## Pump Stop

1. The pump run signal is removed from Terminal 3.
2. 4SV is de-energized, starting pump check valve closure.
3. CR1 is de-energized, opening contact (Line 4).
4. The pump continues to run, powered thru the closed LSC, MLS and MSH contacts (Line 5).
5. When the pump check valve is 70-95% closed, MLS opens momentarily and de-energizes the pump motor starter. If MLS is not used, LSC will turn off pump when valve is fully closed.
6. Pump "Run" and valve "Open" lights are de-energized.

## Pump Safety Stop

1. Upon loss of all electrical power, the 2SV solenoids (Line 3) are de-energized, closing the pump check valve at the emergency rate.
2. If the pump motor starter overloads (Line 5) open, 4SV and 2SV are de-energized, closing the pump check valve at the emergency rate.
3. If the valve fails to begin opening in 10-120 seconds (adjustable), the time delay relay contact (Line 8) energizes the alarm lock-out relay CR2. CR2 contact (Line 1) initiates "Pump Stop" sequence above, and energizes "Emerg. Stop" light. Pump can not be restarted until "Reset" button is pressed.
4. In case of line blockage or inadvertent valve closure, the pump discharge pressure will rise to the pump shut-off pressure and close PS2 (Line 12). PS2 will energize TR initiating the "Pump Stop" sequence and energizing "Emerg. Stop" light. (PS2 is optional).
5. In case of line break or parallel pump trip, the pump discharge pressure will fall below normal pressure and close PS3 (Line 13). PS3 will energize TR initiating the "Pump Stop" sequence and energizing "Emerg. Stop" light. (PS3 is optional).
6. In case of local emergency, the red "Stop" button (Line 10) can be pressed. The valve will close at the normal rate and shut off the pump when MLS setting is reached (Line 5).
7. Remote "Emerg. Stop" alarm contact, CR2 (Line 13) is provided. (10 amp max.)

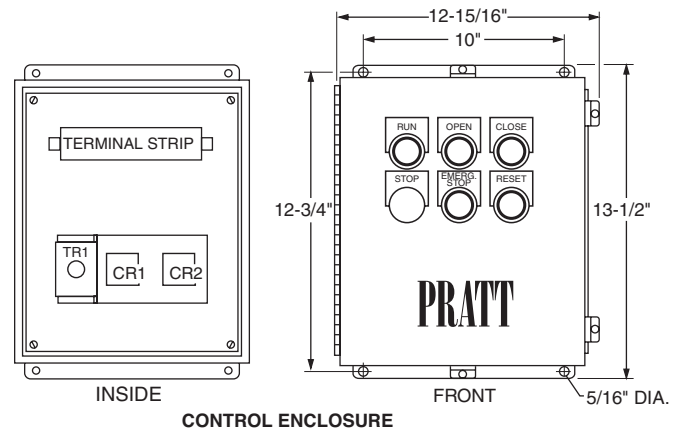

## Suggested Specification

In addition to the pump check valve hydraulic controls, an electric control panel shall be supplied containing all necessary relays, timers, buttons and lights to interface the pump controls with the pump check valve controls. The panel shall provide for:

1. Visual indication of valve position with red and green indicating lights.
2. Visual indication of alarm conditions with amber flashing light.
3. Emergency shut down of pump and valve by an external button.
4. Pump system lockout after an alarm condition. System to be started again only after the reset button is pressed.

The alarm function of the panel shall include an adjustable solid state timing relay, lockout relay, flashing light and reset button. The controls shall be housed in a continuous hinge NEMA 4 cabinet suitable for wall mounting. Each alarm relay shall have a set of contacts wired to the terminal strip for remote indication.

The control system shall be the Standard Electro-Check, Diagnostic Electro-Check system as manufactured by the Henry Pratt Company.

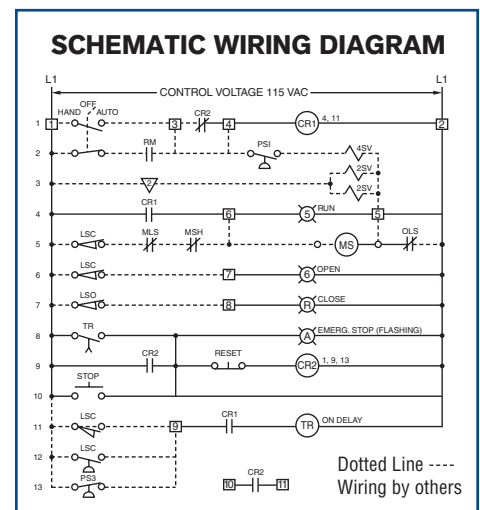

## Optional Equipment:

- Pressure switches
- Individual Alarm Pilot Lights for pump failure, low pressure, and high pressure conditions.
- Cabinet floor stand
- Individual Lockout Timers for monitoring alarm conditions

# PRATT PRODUCT GUIDE

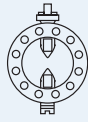

**Model  
2FI**



**Monoflange  
MKII**

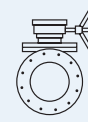

**Plug  
Valve**

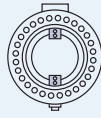

**Triton®  
XR70**

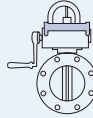

**Indicating Butterfly Valve  
UL & FM approved**

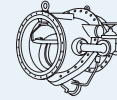

**Tilting Disc  
Check Valve**

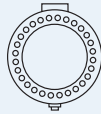

**Triton®  
XL**

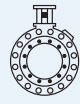

**N-Stamp Nuclear  
Butterfly Valve**

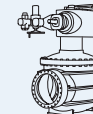

**Cone  
Valve**

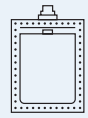

**Rectangular**

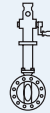

**PIVA Post Indicating Valve Assembly  
UL & FM approved**

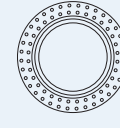

**Sleeve  
Valve**

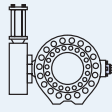

**Rubber Seated  
Ball Valve**

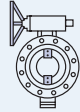

**Triton®  
HP250**

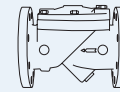

**Check  
Valve**

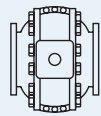

**Metal Seated  
Ball Valve**



**Control  
Systems**

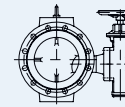

**Plunger Valve**

**PRATT**

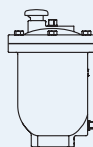

**Air Valve**

**Henry Pratt Company**

401 South Highland Avenue  
Aurora, Illinois 60506-5563 - US  
P: 630-844-4000 F: 630-844-4160  
www.henrypratt.com  
ISO 9001: 2000 Certified